



Instructions

MakerStudio™

Gears Set



Cable Car
Build Instructions

YOU CAN ALSO MAKE:

Racecar
3-Wheeler
Motorcycle

WARNING:
Toy contains functional sharp point.
CHOKING HAZARD—Small parts.
Not for CHILDREN UNDER 3YRS.

AGES 7 TO ADULT

Cable Car

ENGINEERING
CHALLENGE
#5

ENGINEERING
CHALLENGE
#6

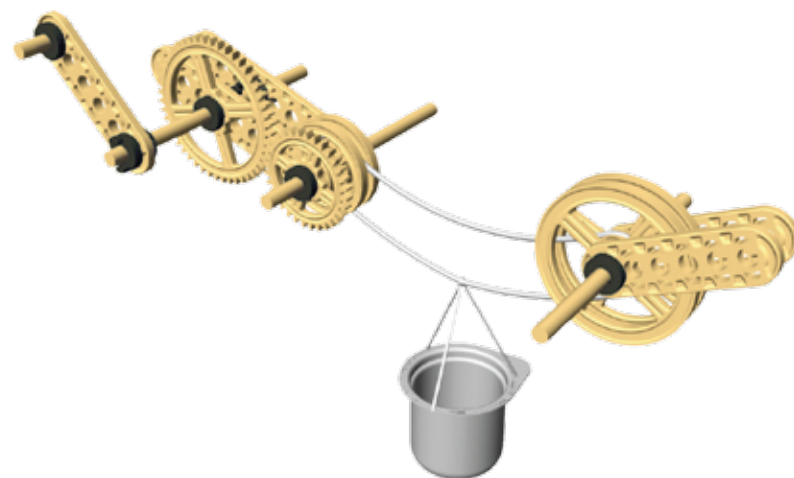

Parts:

Tools:

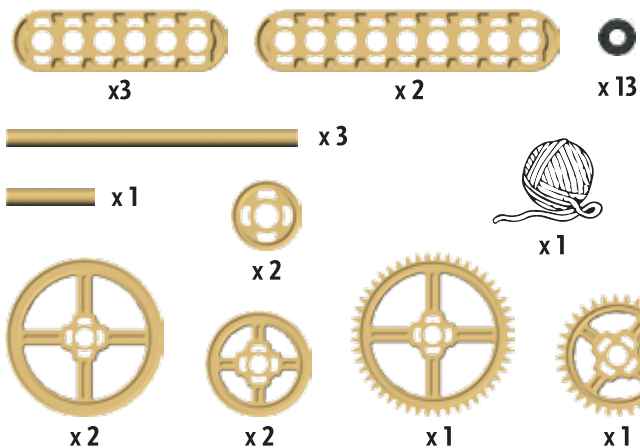

This work is licensed under a Creative Commons Attribution-NonCommercial 4.0 International License. You are free to share and build upon these files in your new creations, but you may not use these files for commercial purposes. For a complete copy of the license, visit creativecommons.org/licenses/by-nc/4.0/.

1. _____

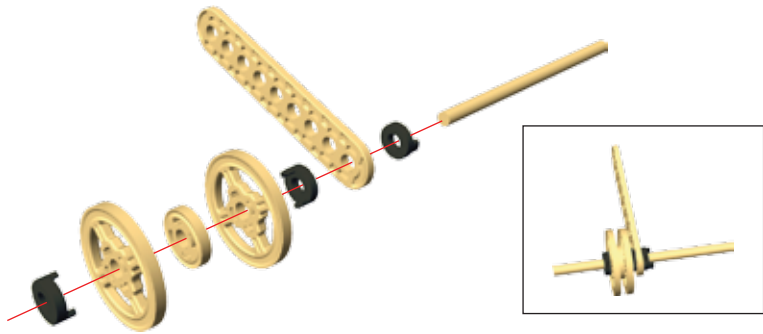

2. _____

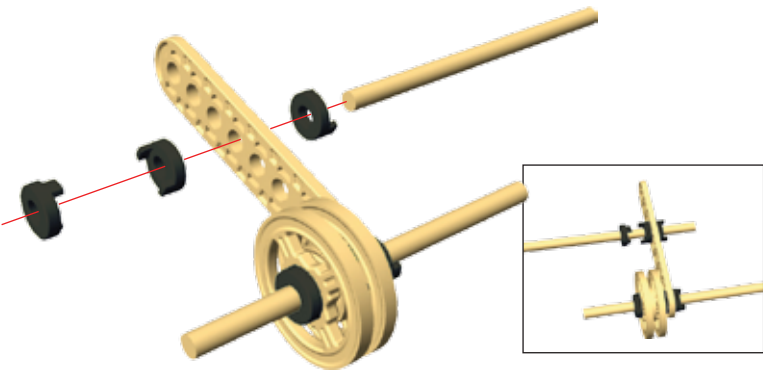

3. _____

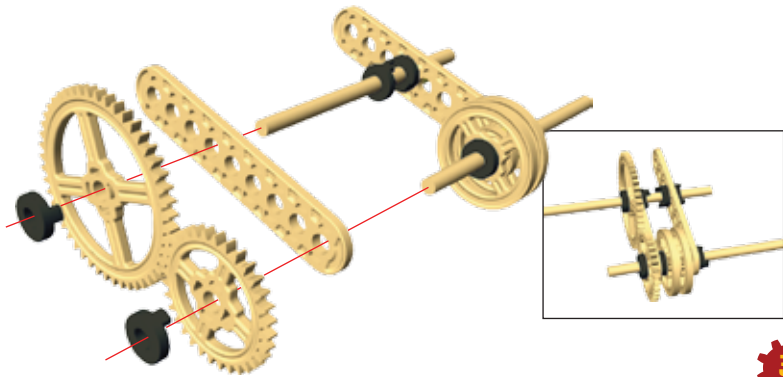

4. _____

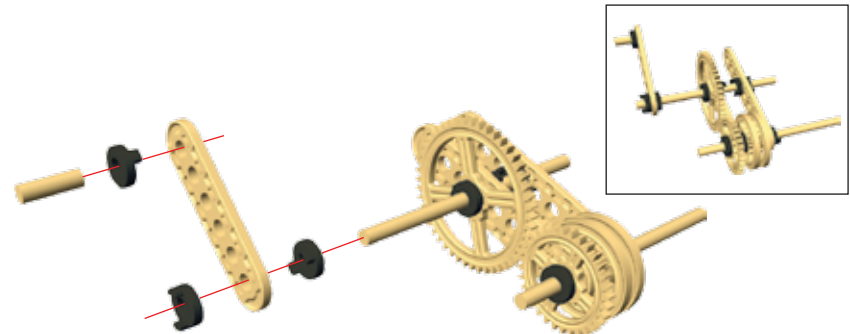

5. _____

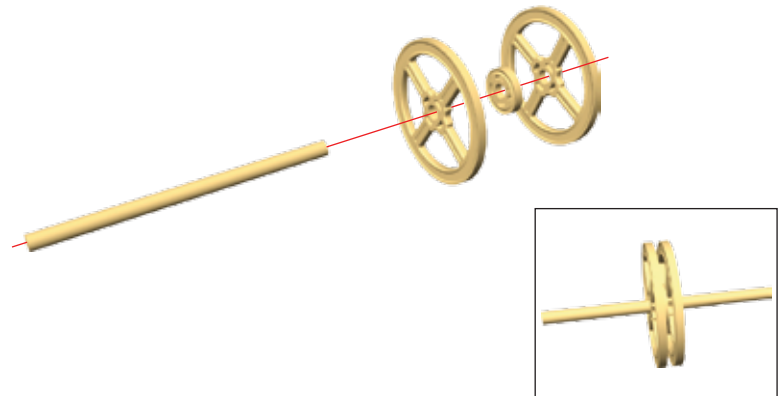

6. _____

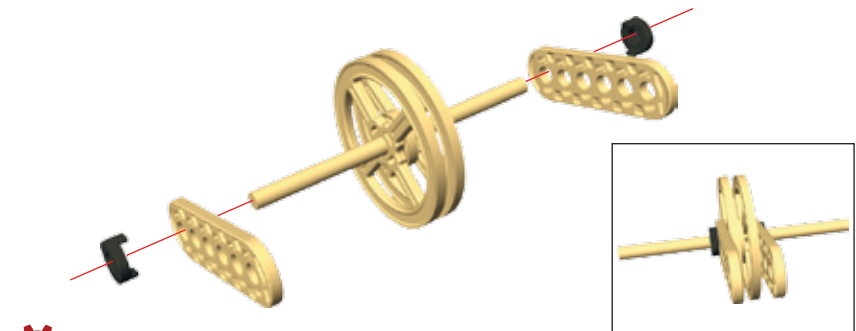

This work is licensed under a Creative Commons Attribution-NonCommercial 4.0 International License. You are free to share and build upon these files in your new creations, but you may not use these files for commercial purposes. For a complete copy of the license, visit creativecommons.org/licenses/by-nc/4.0/.

7.

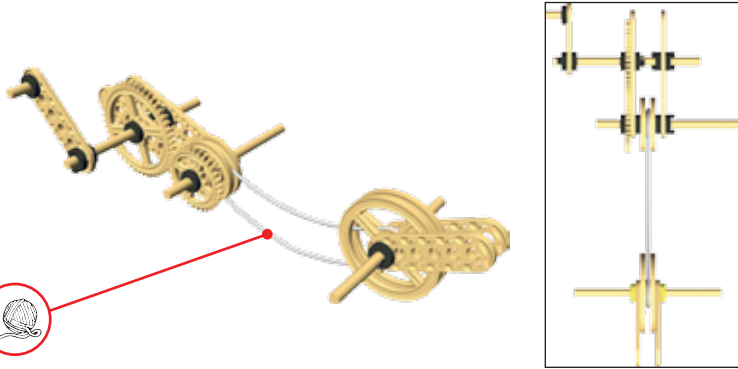

8.

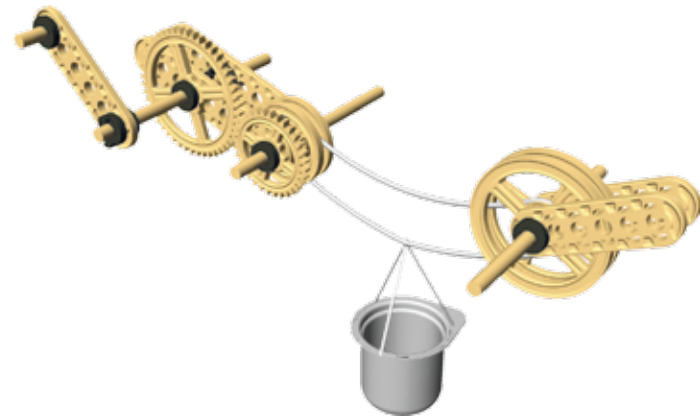

ThinkFun's Mission is to Ignite Your Mind!®

ThinkFun® is the world's leader in addictively fun games that stretch and sharpen your mind. From lighting up young minds to creating fun for the whole family, ThinkFun's innovative games and mobile apps make you think while they make you smile.



www.ThinkFun.com



© 2014 ThinkFun Inc. All Rights Reserved.
MADE IN CHINA, 104. #1701. IN01.



This work is licensed under a Creative Commons Attribution-NonCommercial 4.0 International License. You are free to share and build upon these files in your new creations, but you may not use these files for commercial purposes. For a complete copy of the license, visit creativecommons.org/licenses/by-nc/4.0/.