



# Instructions

# MakerStudio™

## Gears Set

Motorcycle  
Build Instructions

**YOU CAN ALSO MAKE:**

Racecar  
3-Wheeler  
Cable Car

**WARNING:**  
Toy contains functional sharp point.  
CHOKING HAZARD—Small parts.  
Not for CHILDREN UNDER 3YRS.

AGES 7 TO ADULT

### Motorcycle

ENGINEERING  
CHALLENGE  
#7

ENGINEERING  
CHALLENGE  
#8

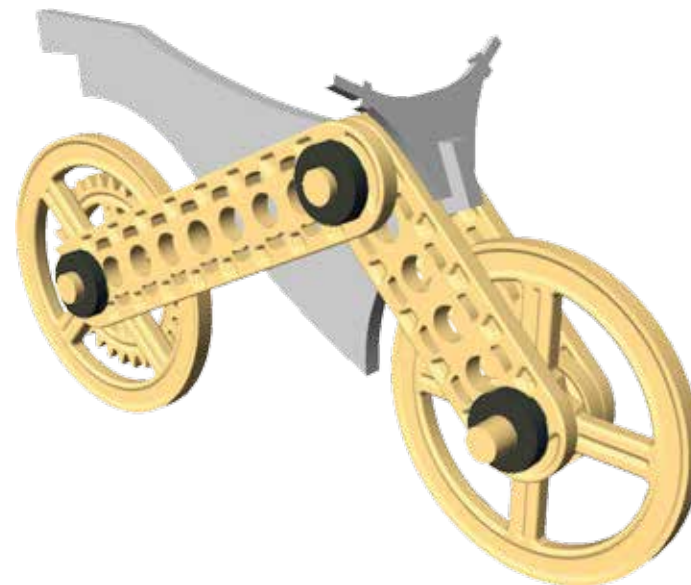
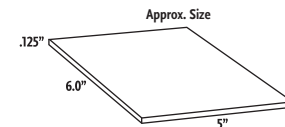

#### Parts:

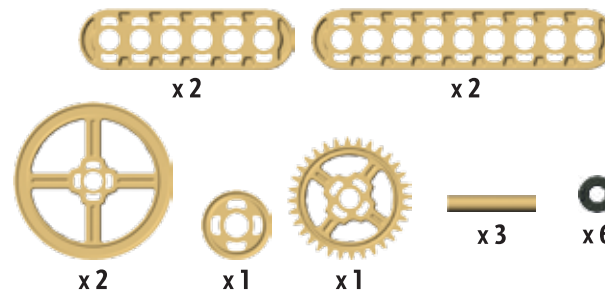

#### Tools:



This work is licensed under a Creative Commons Attribution-NonCommercial 4.0 International License. You are free to share and build upon these files in your new creations, but you may not use these files for commercial purposes. For a complete copy of the license, visit [creativecommons.org/licenses/by-nc/4.0/](https://creativecommons.org/licenses/by-nc/4.0/).

1. \_\_\_\_\_

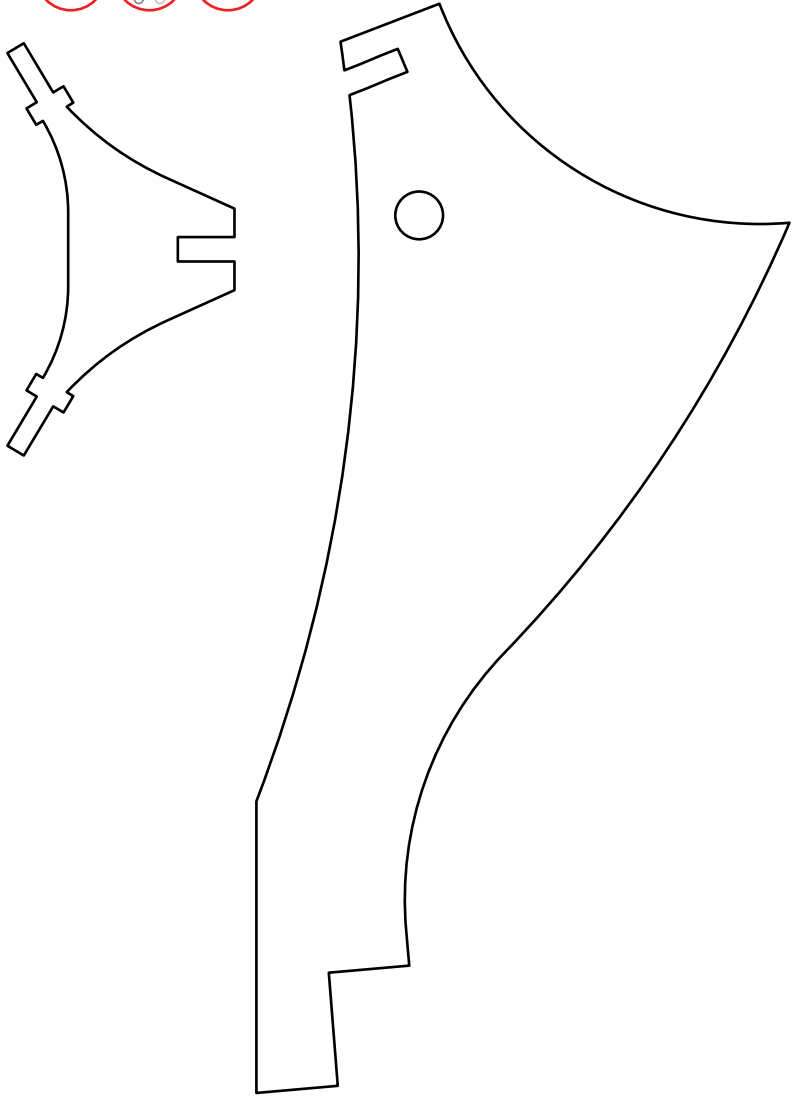

2. \_\_\_\_\_

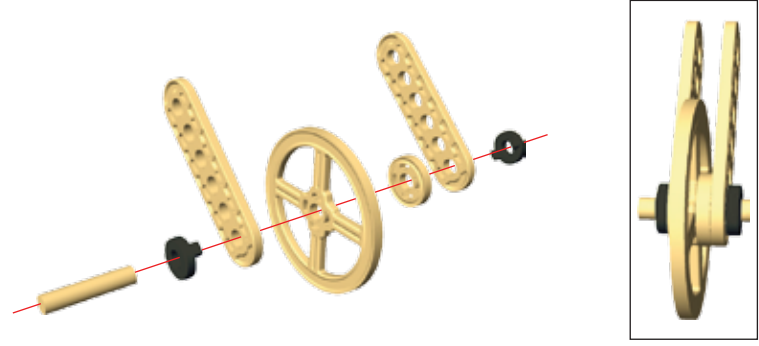

3. \_\_\_\_\_

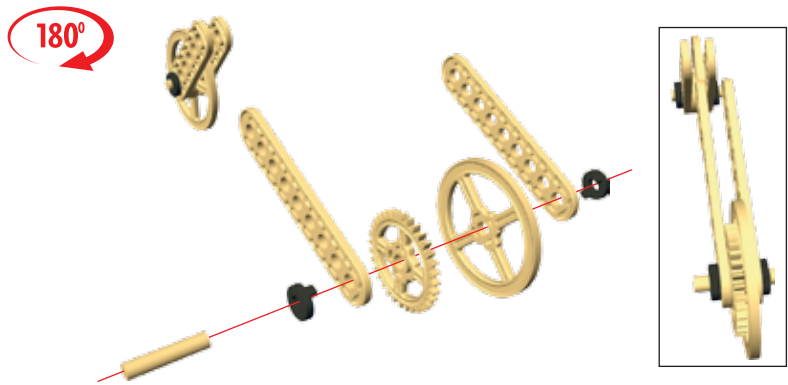

4. \_\_\_\_\_

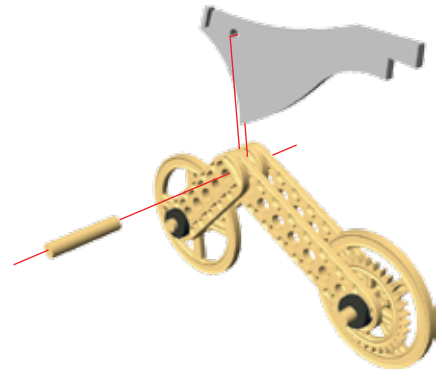

This work is licensed under a Creative Commons Attribution-NonCommercial 4.0 International License. You are free to share and build upon these files in your new creations, but you may not use these files for commercial purposes. For a complete copy of the license, visit [creativecommons.org/licenses/by-nc/4.0/](https://creativecommons.org/licenses/by-nc/4.0/).

5.

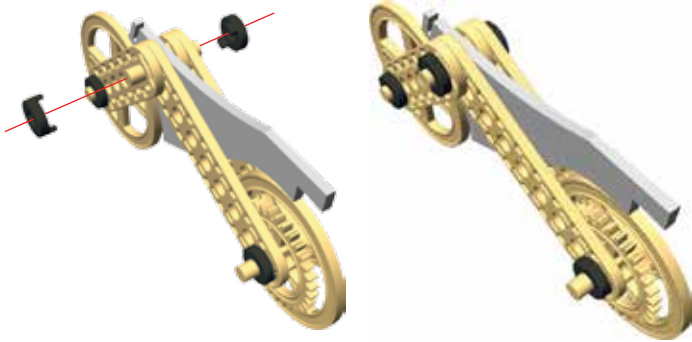

6.

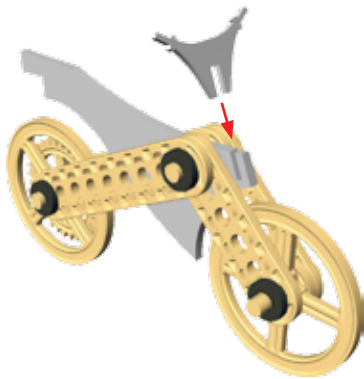

7.

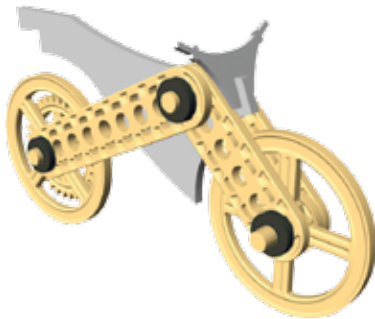

# ThinkFun's Mission is to Ignite Your Mind!®

ThinkFun® is the world's leader in addictively fun games that stretch and sharpen your mind. From lighting up young minds to creating fun for the whole family, ThinkFun's innovative games and mobile apps make you think while they make you smile.



[www.ThinkFun.com](http://www.ThinkFun.com)



© 2014 ThinkFun Inc. All Rights Reserved.  
MADE IN CHINA, 104. #1701. IN01.



This work is licensed under a Creative Commons Attribution-NonCommercial 4.0 International License. You are free to share and build upon these files in your new creations, but you may not use these files for commercial purposes. For a complete copy of the license, visit [creativecommons.org/licenses/by-nc/4.0/](http://creativecommons.org/licenses/by-nc/4.0/).