

AGES
8 to adult
multiple players

YOUR GOAL: Use the Scoring Dice to match or come closest to the Target Number.

Roll the two 12-sided Target Dice.
Multiply the two numbers to get the TARGET NUMBER.

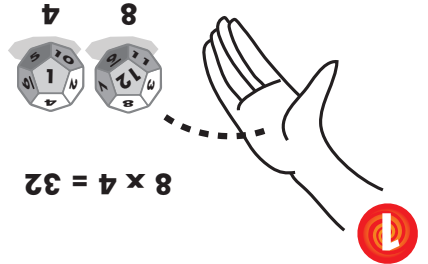

Roll the three 6-sided Scoring Dice. Combine the numbers in any way to match, or come closest to, the TARGET NUMBER.

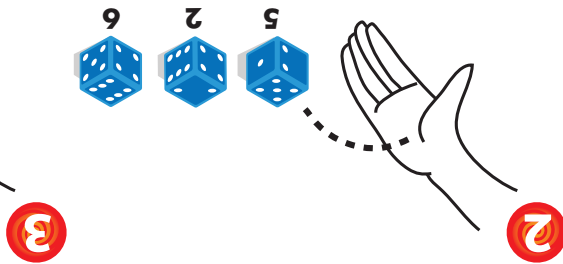

The winner is the first player to match or come closest to the TARGET NUMBER!

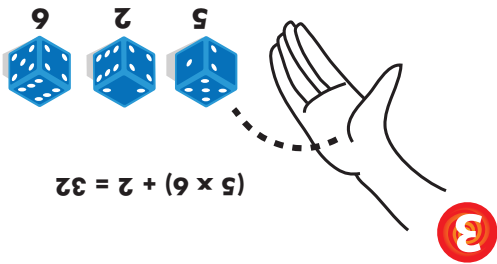

The Fast Fun Game of Mental Math

MATHDICE



MATHDICE

The Fast Fun Game of Mental Math

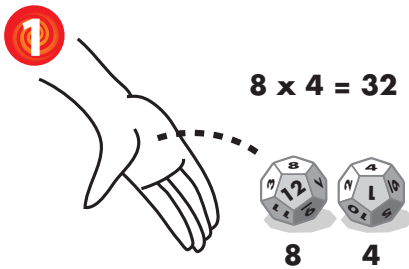

Roll the two 12-sided Target Dice.
Multiply the two numbers to get the TARGET NUMBER.

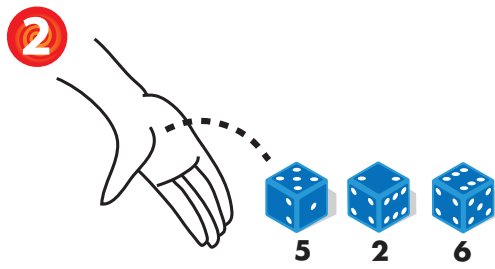

Roll the three 6-sided Scoring Dice. Combine the numbers in any way to match, or come closest to, the TARGET NUMBER.

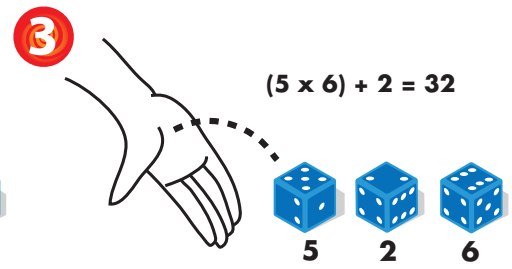

The winner is the first player to match or come closest to the TARGET NUMBER!

YOUR GOAL: Use the Scoring Dice to match or come closest to the Target Number.

AGES
8 to adult
multiple players

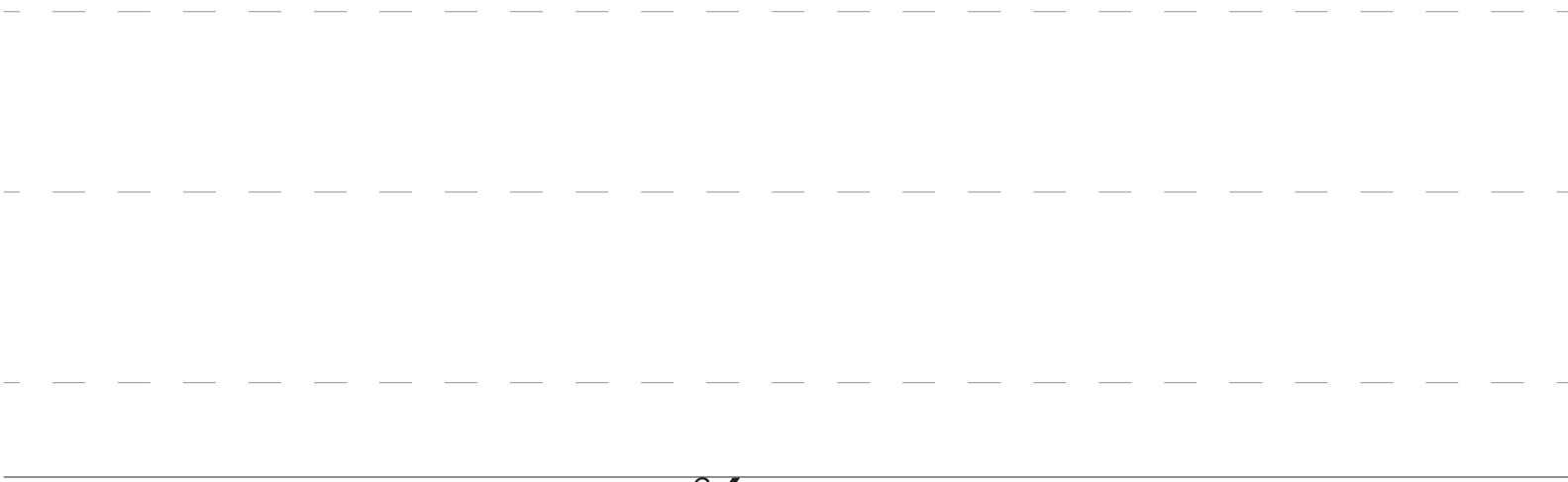

1

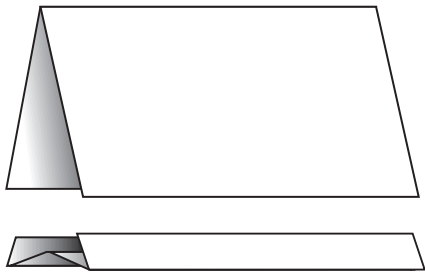

Cut out and fold tent & base.

2

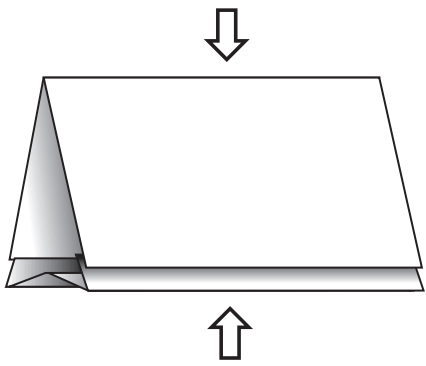

3

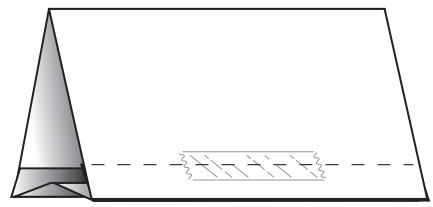

Tape tent to base inside.